

# mat.works

Entrance Solutions

part of the group

paragon  
CARPET TILES

Mat.Works is a Division of National Floorcoverings Ltd,  
the UK's leading manufacturer of commercial floor coverings.

# entrance solutions

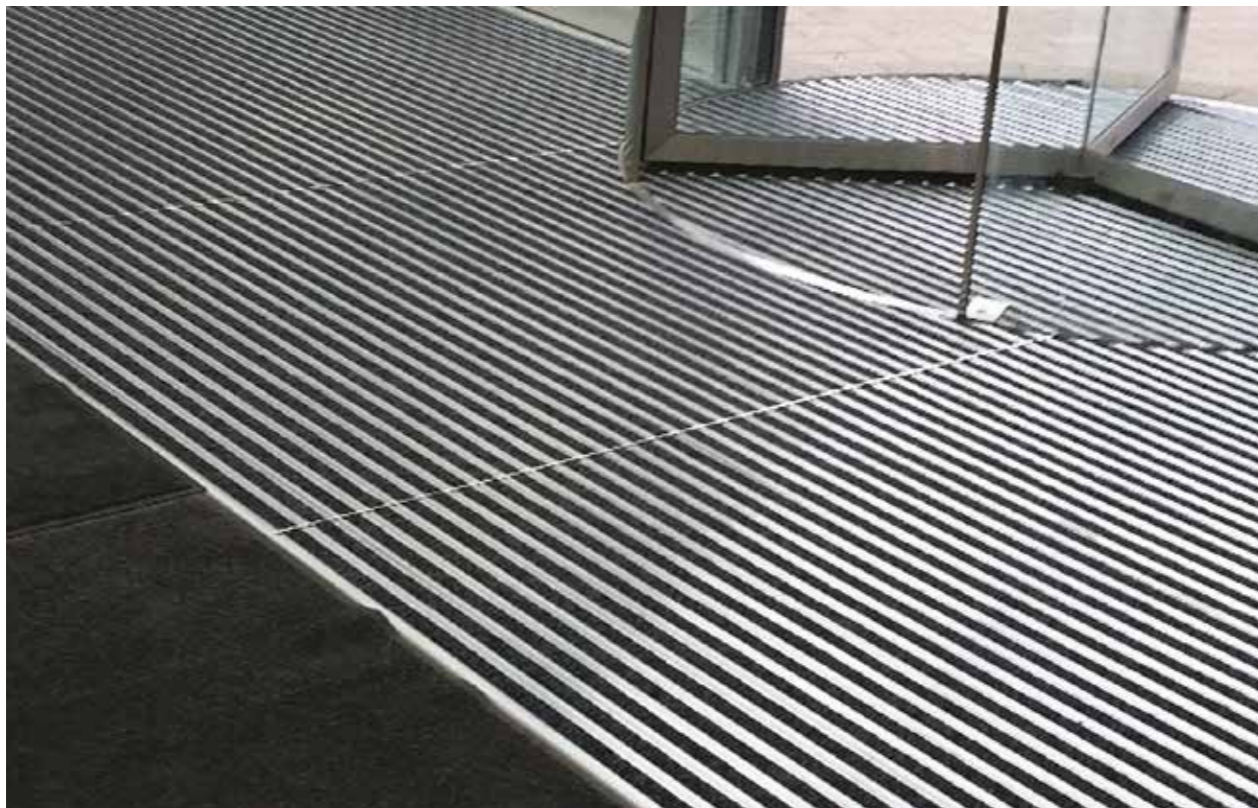

# contents

## Aluminium primary entrance solutions

- pg04 How to specify entrance products
- pg10 Frameworks 12
- pg11 Frameworks 15C
- pg12 Frameworks 17C & 22C
- pg13 Frameworks 17OP & 22OP
- pg14 Frameworks 17CS
- pg16 Frameworks Clic-Fix

## Primary modular solutions

- pg20 Treadloc 25
- pg22 Treadloc 25 Ramping Solution
- pg24 Treadsure 205
- pg26 Entrack 50
- pg30 Tyre Tile

## Secondary entrance solutions

- pg34 Workspace Entrance
- pg35 Premier
- pg36 MW Maxim
- pg37 MW Rib HD
- pg38 DDA Coir
- pg39 Ext Mat
- pg40 Loose Lay Mats

## Logo matting

- pg44 MW Print Mat
- pg45 Coir Logo
- pg46 Brush Logo
- pg47 Outdoor Logo Mat
- pg48 MW Maxim Logo
- pg49 MW Runner Mat
- pg50 MW Event Mat

## Technical

- pg51 Accessories
- pg52 Cleaning & Maintenance
- pg55 National Floorcoverings
- pg56 Contact Details

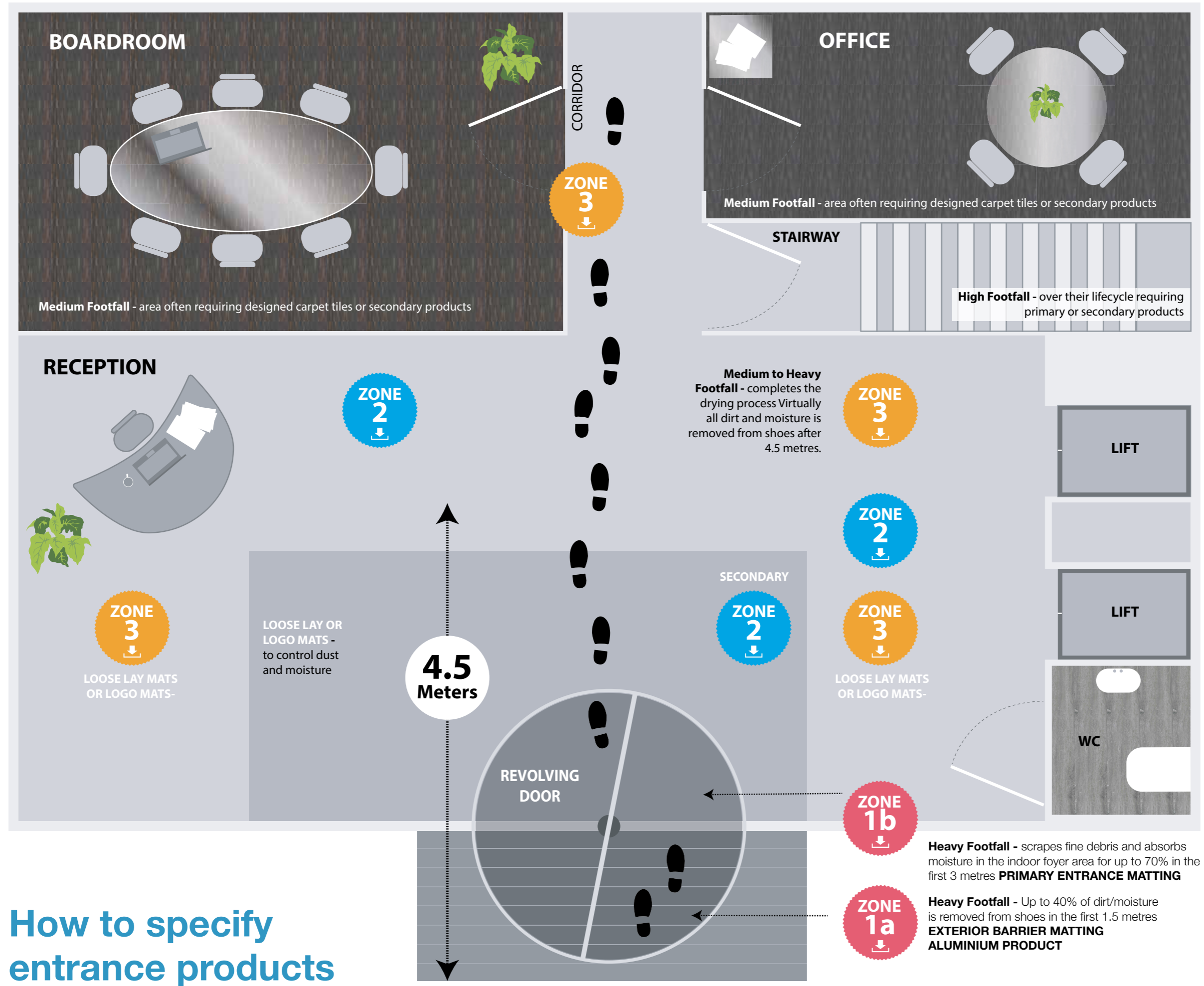

**ZONE 1**

In Zones 1a and 1b the installation of exterior matting catches the first wave of heavy debris in a high traffic area, ensuring the removal of up to 40% of dirt and moisture from entering the building. An effective primary entrance mat will continue the removal of dirt and moisture working with the external matting containing any heavy debris.

**ZONE 2**

In these zones a high specification secondary barrier mat will continue the cleaning and scraping process, removing up to 70% of remaining dirt and moisture. At this stage dust is also driven into the matting rather than remaining airborne.

**ZONE 3**

In buildings with a very high volume of traffic, primary matting is often supplemented into secondary areas, loose lay matting and logo mats are used to reduce dust migration throughout main corridors and completely remove remaining dirt and moisture from shoes completing the drying process and protecting your building investment.

## How to specify entrance products

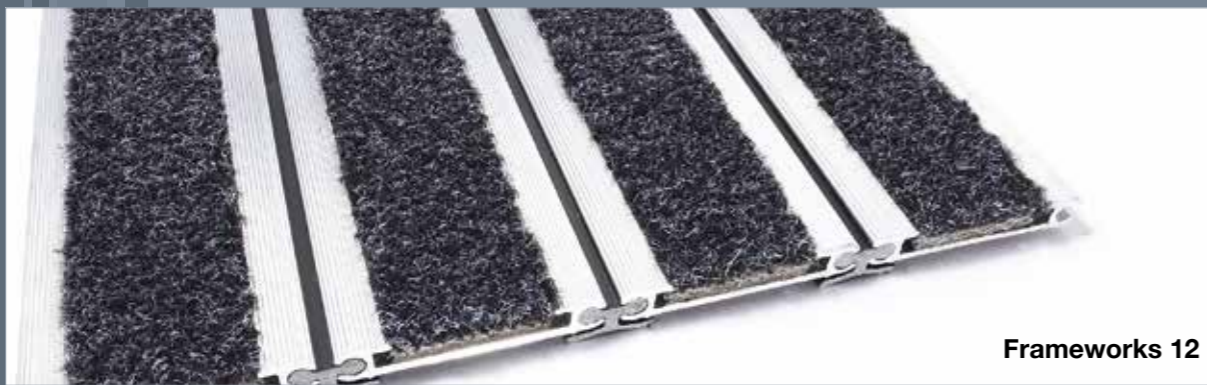

Frameworks 12

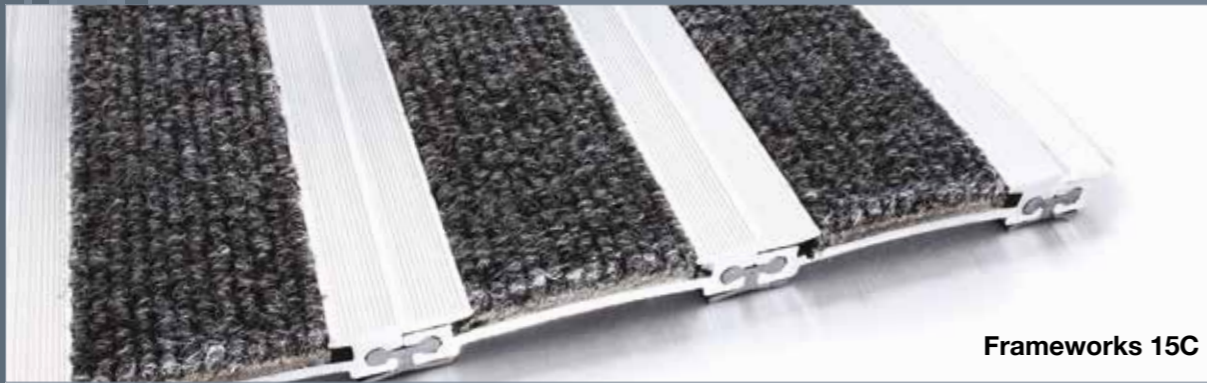

Frameworks 15C



Frameworks 17C & 22C



Frameworks 17OP & 22OP



Frameworks Clic-Fix



# aluminium primary entrance solutions

FRAMEWORKS  
FRAMEWORKS CLIC-FIX

# FRAMEWORKS

Frameworks is a unique range of tough and durable aluminium extruded entrance systems with a range of insert options.

## How to choose your frameworks system\*:

### Stage 1: Select your height

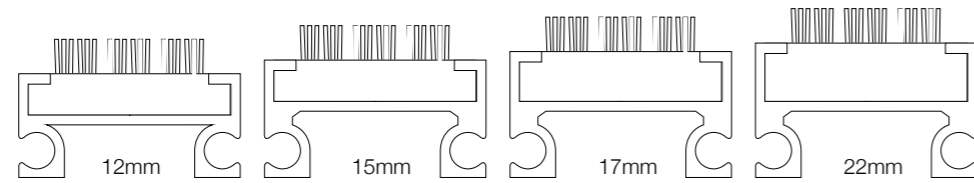

### Stage 2: Pick your construction

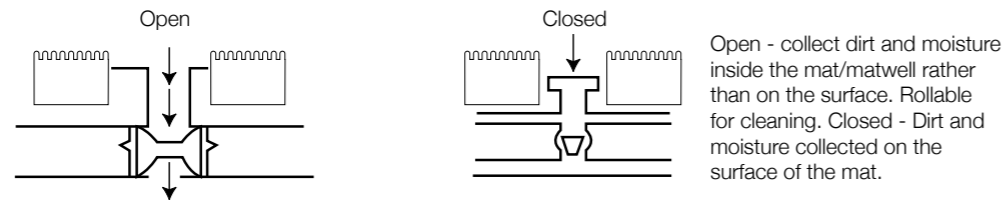

### Stage 3: Pick your insert from 13 options

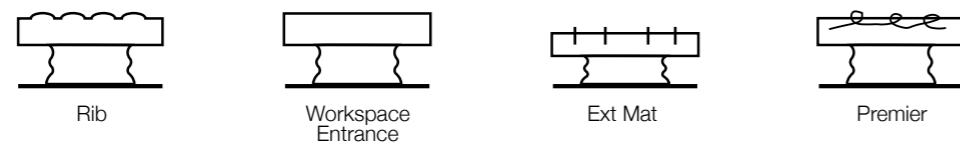

Frameworks 12

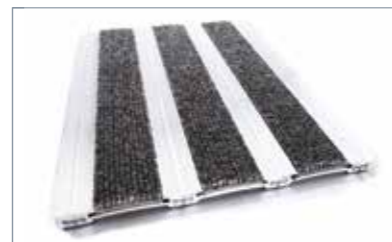

Frameworks 15C

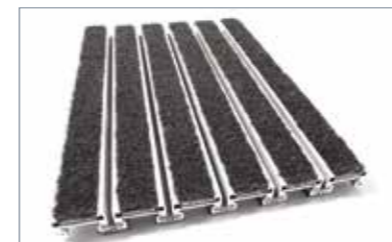

Frameworks 17OP

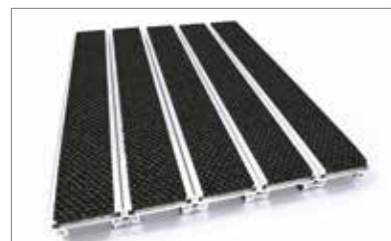

Frameworks 17C

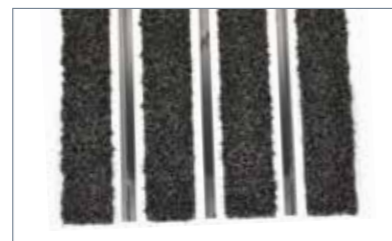

Frameworks 22OP



Frameworks 22C



Frameworks 17CS

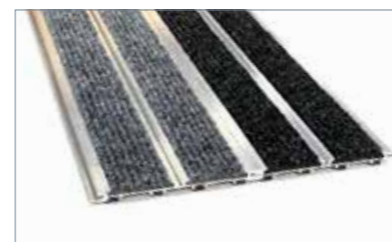

Frameworks Clic-Fix

\* Not including Frameworks Click-Fix

C = Closed | OP = Open | CS = Closed Scraper | DR = Drainable

## Available colourways:

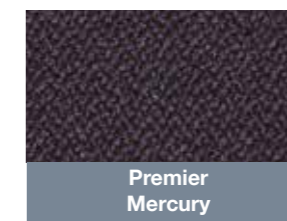
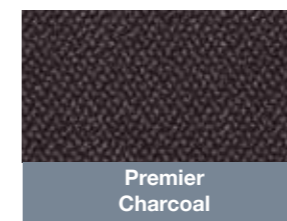
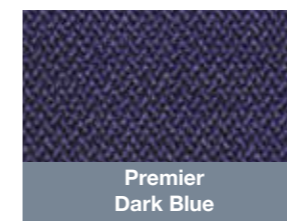
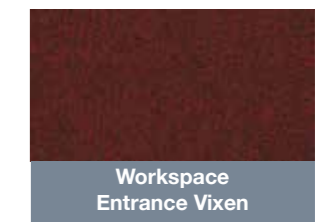
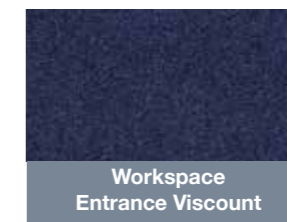
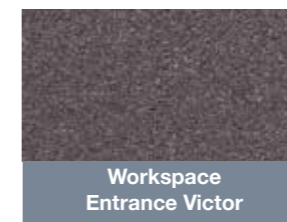
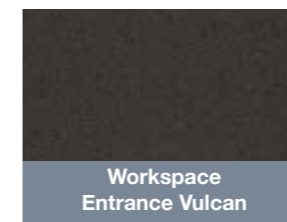
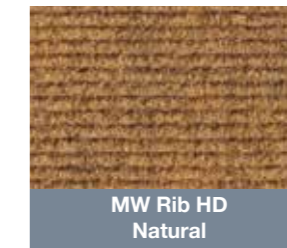

## MW Maxim

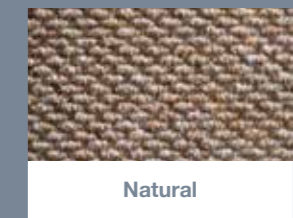
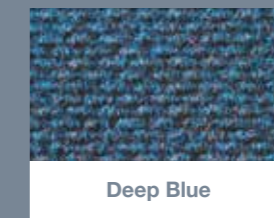
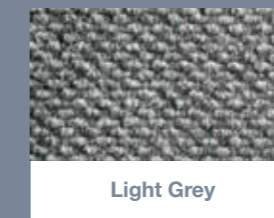
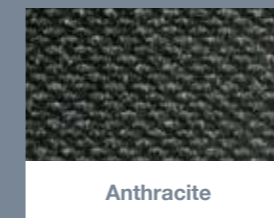

## Accessories:

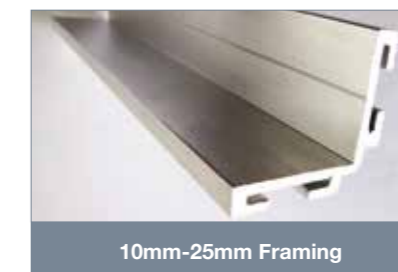

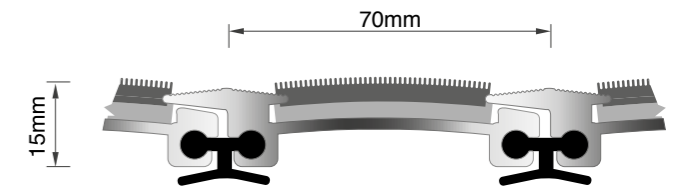
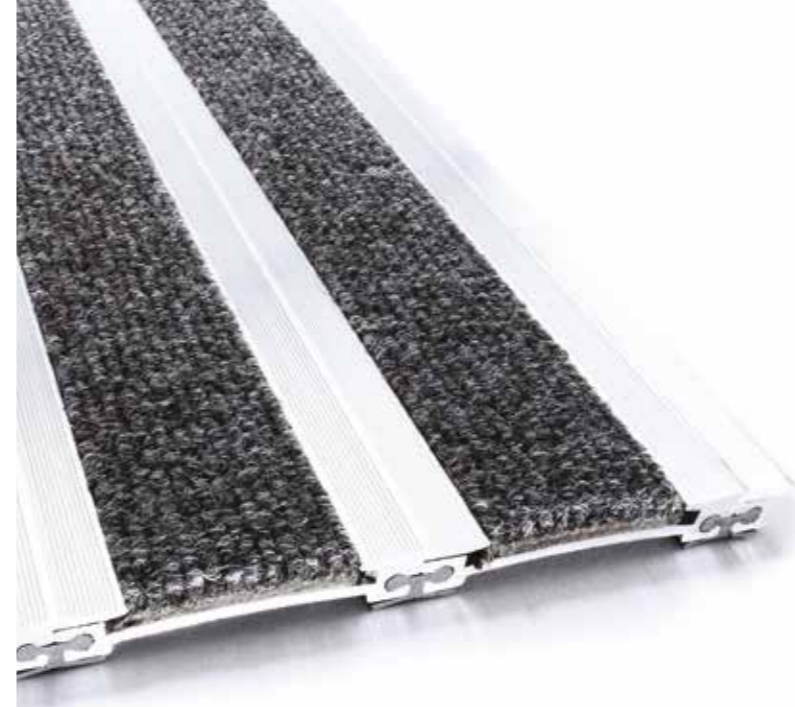
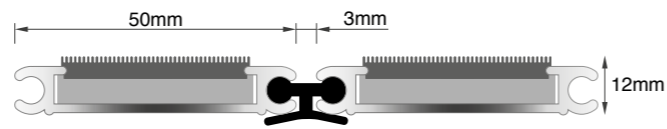

Mat.Works provides a survey and installation service on all Frameworks projects.



## FRAMEWORKS 12

### Description:

Low profile rollable aluminium grid matting system suitable for heavy traffic areas.

Ideal for recess matwells or areas where surface mounting is required.

The extruded aluminium profiles are assembled using PVC hinges which incorporate an integral damper strip. PVC hinges enable easier on site shaping.

Custom made to required sizes.

Ramping available for surface mounting.

Insert options available to allow for external use.

Anodised version available in black and bronze.

### Colours:

16 colour options available: see page 9.

### Accessories:

Frameworks accessories – see page 56 for further details. For simple rectangular mats, Frameworks can be made to exact requirements. For more complicated shapes, Mat.Works recommends one of our approved installers.



## FRAMEWORKS 15C

### Description:

Heavy gauge 15C entrance matting system.

Frameworks 15C incorporates an arch form heavy gauge aluminium chassis, capable of withstanding extreme traffic in the most demanding applications.

42mm wide wiper inserts provides optimum contact area for absorbency and soil collection.

Wide variety of wiper strips to suit almost any application with 16 different colourways.

Assembled using PVC hinges which incorporate an integral damper strip. PVC hinges enable easier on site shaping.

Custom made to required sizes.

Anodised version available in black and bronze.

### Colours:

16 colour options available: see page 9.

### Accessories:

Frameworks accessories – see page 56 for further details. For simple rectangular mats, Frameworks can be made to exact requirements. For more complicated shapes, Mat.Works recommends one of our approved installers.



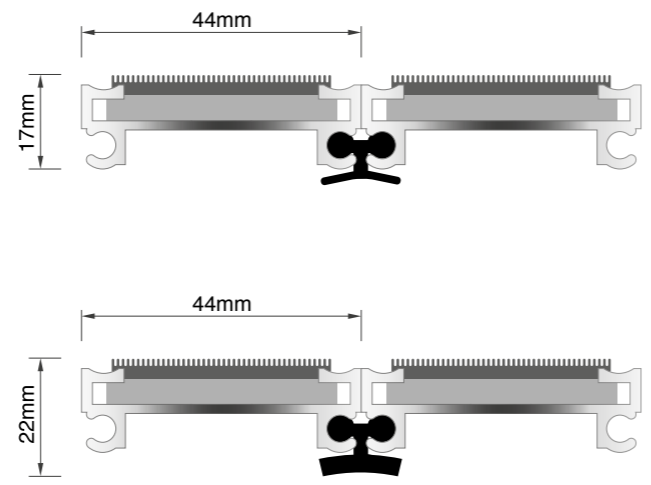

Mat.Works provides a survey and installation service on all Frameworks projects.

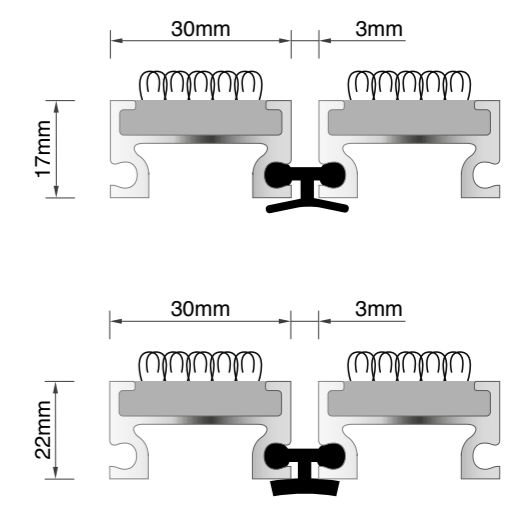

Image features new MW Maxim Anthracite insert



## FRAMEWORKS 17C & 22C

**Description:**  
Heavy duty primary entrance mat with exceptional performance.

Frameworks 17C and 22C closed construction ensures that all debris is captured by the mat surface to ensure a convenient cleaning operation.

Suitable for both footfall and trolley traffic.

Wide variety of wiper strips to suit almost any application with 16 different colourways.

The extruded aluminium profiles are assembled using PVC hinges which incorporates an integral damper strip. PVC hinges enable easier on site shaping.

Anadised version available in black and bronze.

**Colours:**  
16 colour options available: see page 9.

**Accessories:**  
Frameworks accessories – see page 56 for further details. For simple rectangular mats, Frameworks can be made to exact requirements. For more complicated shapes, Mat.Works recommends one of our approved installers.



## FRAMEWORKS 17OP & 22OP

**Description:**  
Frameworks 17OP and 22OP are heavy traffic entrance matting systems. Both systems incorporate a rollable, grid style, open surface construction. The open surface grid system allows dirt to fall into specially designed debris channels whilst allowing the textile inserts to wipe moisture from feet.

Wide variety of wiper strips to suit almost any application with 16 different colourways.

The extruded aluminium profiles are assembled using PVC hinges which incorporates an integral damper strip. PVC hinges enable easier on site shaping.

Custom made to required sizes.

A drainable 17DR is also available.

Anadised version available in black and bronze.

**Colours:**  
16 colour options available: see page 9.

**Accessories:**  
Frameworks accessories – see page 56 for further details. For simple rectangular mats, Frameworks can be made to exact requirements. For more complicated shapes, Mat.Works recommends one of our approved installers.



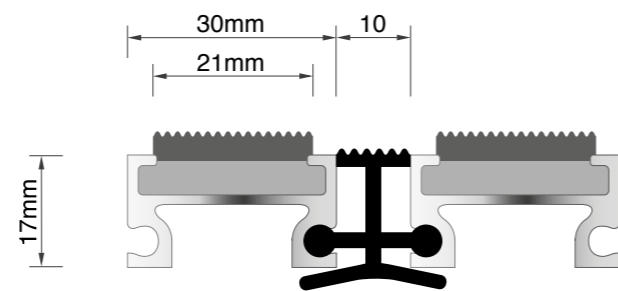

Frameworks 12



Frameworks 17C



# FRAMEWORKS 17CS

## Description:

Frameworks 17CS aluminium based entrance mat is ideal for heavy traffic areas.

Frameworks 17CS is a closed construction primary entrance mat combining textile wiper inserts with alternate PVC scraper bars allowing for dirt and moisture to be taken off in one movement.

Wide variety of wiper strips to suit almost any application with 16 different colourways.

Custom made to required sizes.

Anodised version available in black and bronze.

## Colours:

16 colour options available: see page 9.

## Accessories:

Frameworks accessories – see page 56 for further details. For simple rectangular mats, Frameworks can be made to exact requirements. For more complicated shapes, Mat.Works recommends one of our approved installers.

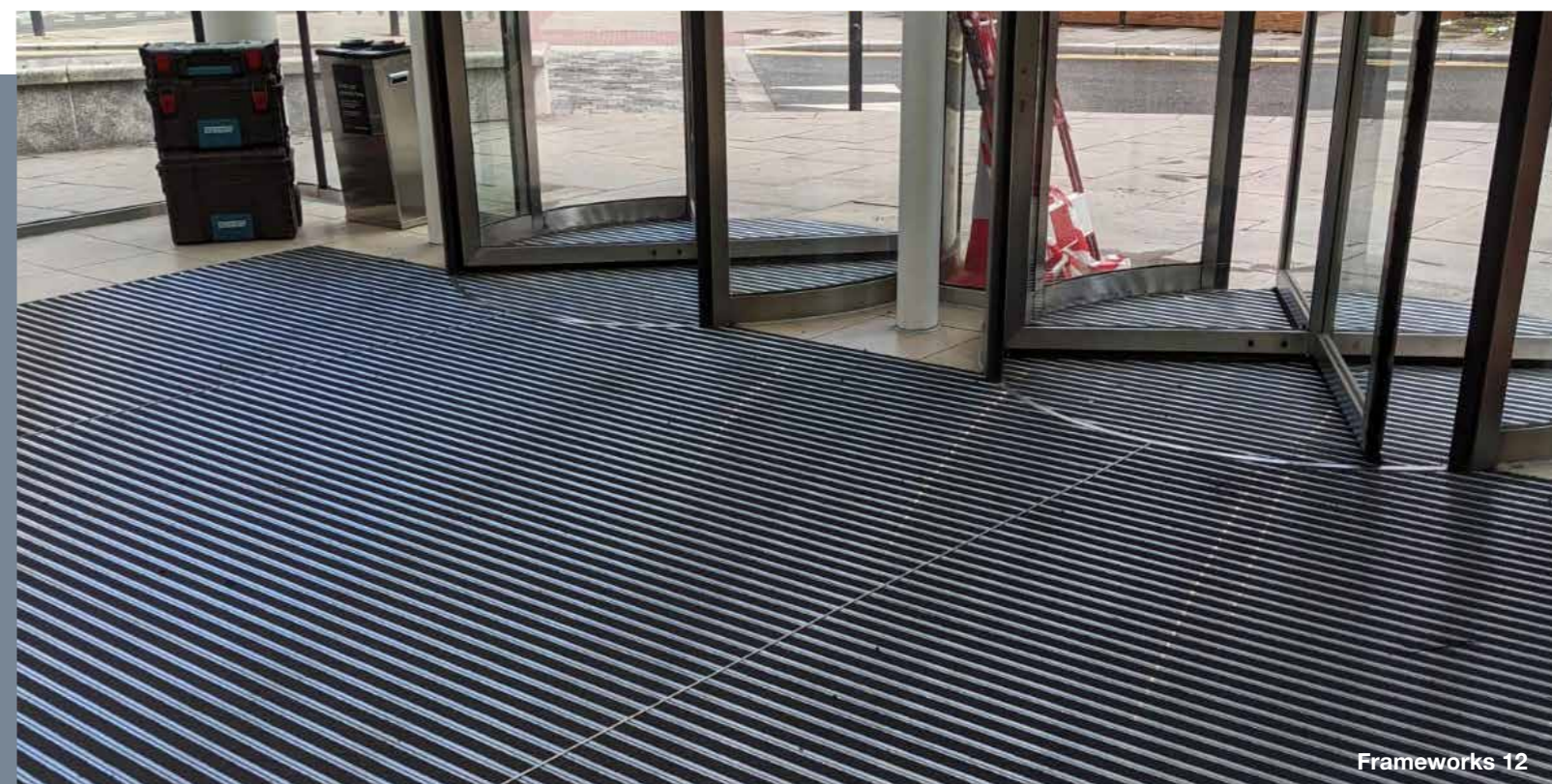

Frameworks 12



Frameworks 22C

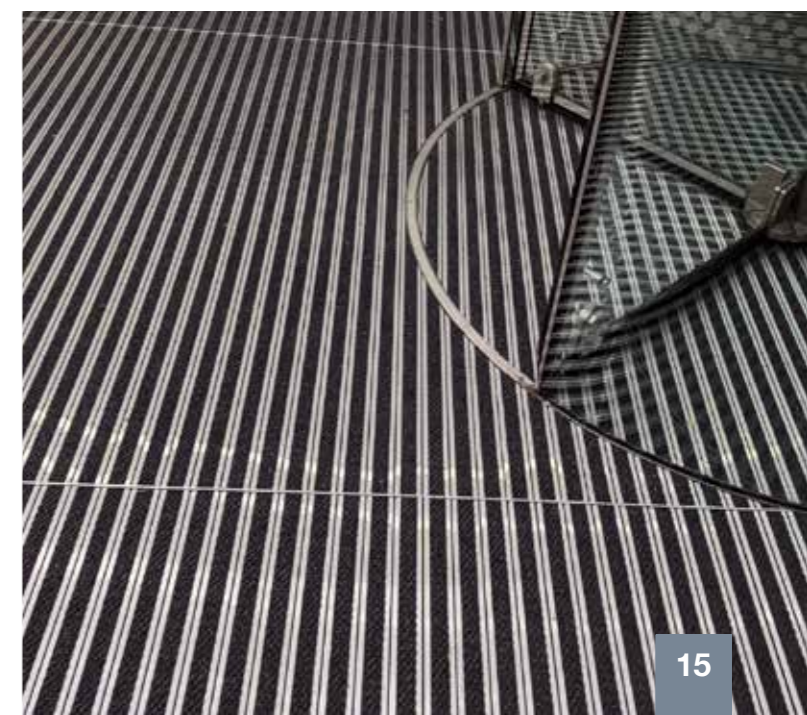





MW Rib HD Light Grey



MW Rib HD Anthracite



MW Rib HD Deep Blue



MW Rib HD Natural



Workspace Entrance Vulcan



Workspace Entrance Victor



Workspace Entrance Viscount



Workspace Entrance Vixen



Mat.Works provides a survey and installation service on all Frameworks projects.

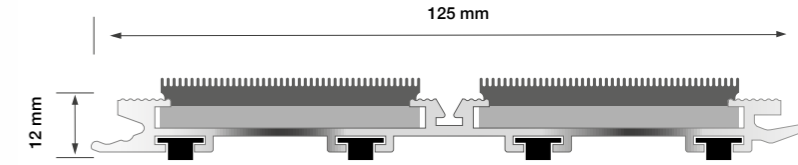

# FRAMEWORKS CLIC-FIX

## Description:

Frameworks Clic-Fix is an innovative new advancement from Mat.Works Entrance Solutions, enabling those from all flooring sectors to install the modular aluminium profiles quickly and simply, in a variety of entranceways.

The pioneering 'Clic-Fix' system enables each aluminium profile to be quite simply 'clicked' together, ensuring the profiles hold and stay in place. This innovative method of fixing empowers a variety of installers to self-fit successfully.

Unlike other products, Frameworks Clic-Fix profiles do not simply 'sit' inside one another, instead they securely connect, preventing any looseness or sliding.

With a 12mm depth, Frameworks Clic-Fix is ideal for recess mat wells or areas where surface mounting is required and is suitable for both internal and external use. It should always be installed onto an even and level surface.

Each individual aluminium profile comes with two wide carpet inserts with a debris channel in between, helping to prevent the ingress of dirt, debris, and moisture into buildings.

Choose from the company's Workspace Entrance or MW Rib HD insert ranges, to create a complete system.

Comes with a 10-year warranty

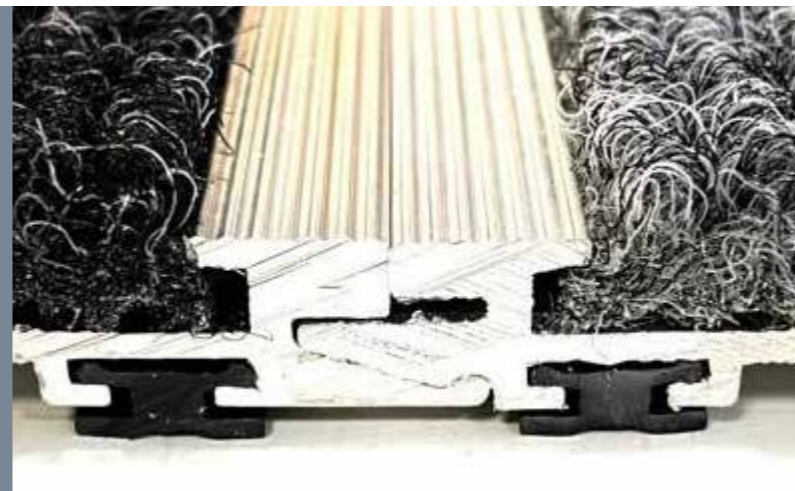

## Technical data:

Module Size	125mm x 12mm (H)
Profile lengths	Available in two standard sizes: 1800mm and 2100mm
Composition	Each aluminium profile has two carpet inserts (45mm), plus 3 PVC dampener strips beneath the base to prevent noise and movement
Performance	Suitable for heavy footfall entrances
Environmental options	Recyclable and reusable
Design	Can be laid uniform with dividing T-bars, or brickbond to avoid waste





Treadloc 25

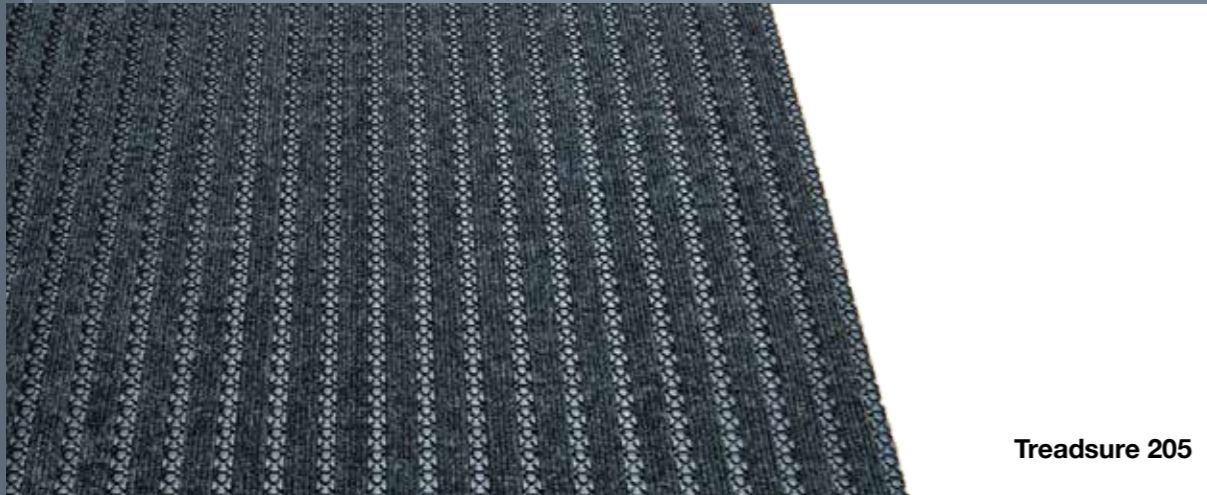

Treadsure 205



Entrack 50



Tyre Tile

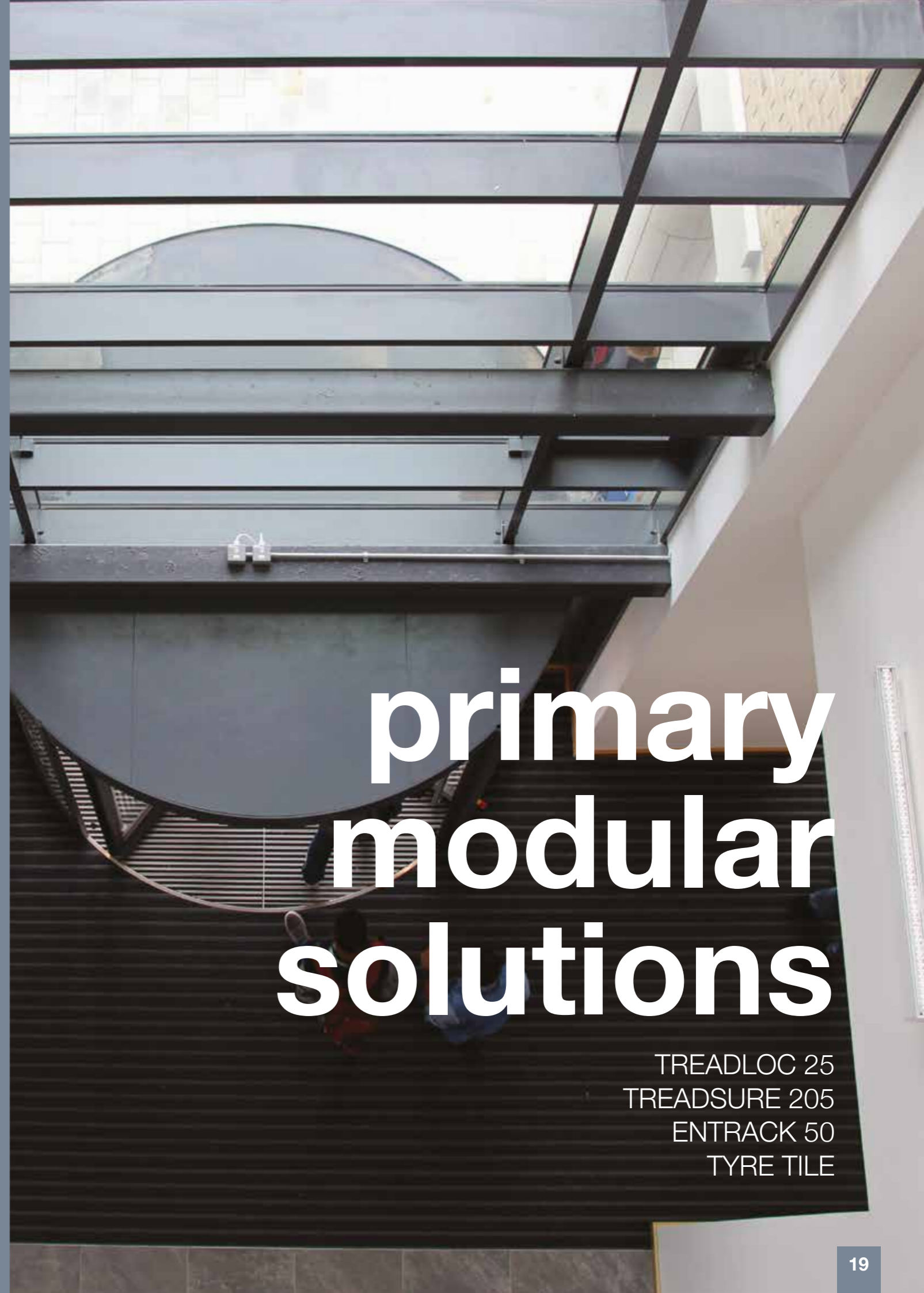

# primary modular solutions

- TREADLOC 25
- TREADSURE 205
- ENTRACK 50
- TYRE TILE

MW Rib HD inserts now available



Anthracite



Light Grey



Deep Blue



Natural

Looking for something different?

Mat.Works provides a host of product inserts in a variety of colours to suit any requirement.



MW Maxim Yellow and MW Maxim Anthracite (Safety Colour Inserts)

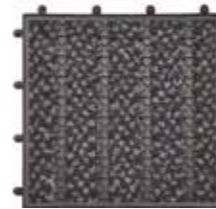

Premier Charcoal Inserts



Workspace Entrance Victor Inserts



Workspace Entrance Viscount Inserts



Workspace Entrance Vulcan Inserts

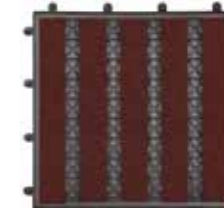

Workspace Entrance Vixen Inserts



Premier Dark Blue Inserts



Premier Mercury Inserts

Mat.Works provides a survey and installation service on all Treadlock 25 projects.



# TREADLOC 25

**Description:**

Treadloc 25 by Mat.Works is a revolutionary modular matting solution. Manufactured from nitrile rubber, the 25cm x 25cm tile may be small but packs an almighty punch when it comes to performance.

Specifically designed to withstand heavy footfall, Treadloc 25 will not expand, contract, fade or become brittle, nor will it bend or buckle under pressure making it an ideal heavy contract solution for entrance areas in every sector. Unlike aluminium solutions, Treadloc 25 can withstand slight undulations in the sub-floor, which are sometimes unavoidable, without compromising the strength and performance of the product.

Treadloc 25 tiles are easily interchangeable and designed with interlocking male and female components for ease of installation. The versatile tiles can be quarter-turned during installation to create a checkerboard effect allowing for multi-directional entrances. There is also the added benefit of being able to purchase individual Treadloc 25 tiles, meaning any damaged tiles can be replaced with ease.

**Technical data:**

Tile size mm	250 mm x 250 mm x 12
Locking guides	Easy Inter-locking system as standard. Removable male and female connectors.
Composition	Nitrile rubber composition
Performance	Nitrile rubber is resistant to oil, grease & fuel.
Wear classification	Heavy contract class 33

Twice the weight of leading competitor products - twice the durability

Treadloc 25 provides a flammability rating of Cfl-s2 (BS EN 14041:2004)



**Perfect for Healthcare**

The nitrile rubber in Treadloc 25 is now manufactured with copper compounds, a material that has been proven to have anti-microbial properties, combating the spread of hospital-acquired infections, including MRSA.



The product has been tested to ISO 22196, which specifies a method of evaluating the antibacterial activity of antibacterial-treated plastics, and other non-porous surfaces of products.

The results showed that the copper in the Treadloc 25 killed 99.29% of MRSA Bacterium.

When examined under the Coefficient of Friction test (TRRL Pendulum test in accordance with BS 7976-2:200+A1:2013), Treadloc 25 has been proven to provide a low risk for slips in both dry and wet conditions.



No matwell or recess? No problem!  
Treadloc 25 has an optional click-fit ramping system...



Dimensions: W 125mm x H 125mm

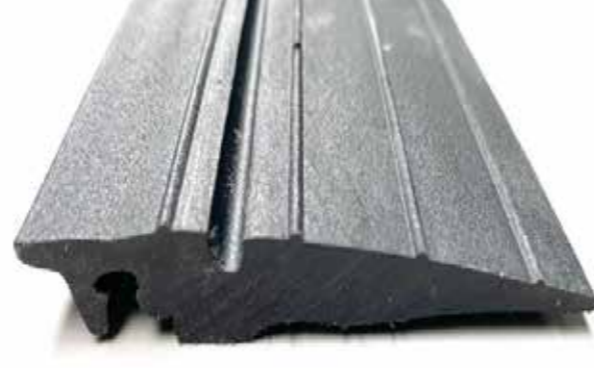

Dimensions: W 66mm x L 2000mm x H 10mm



Treadloc 25 shown in recessed matwells

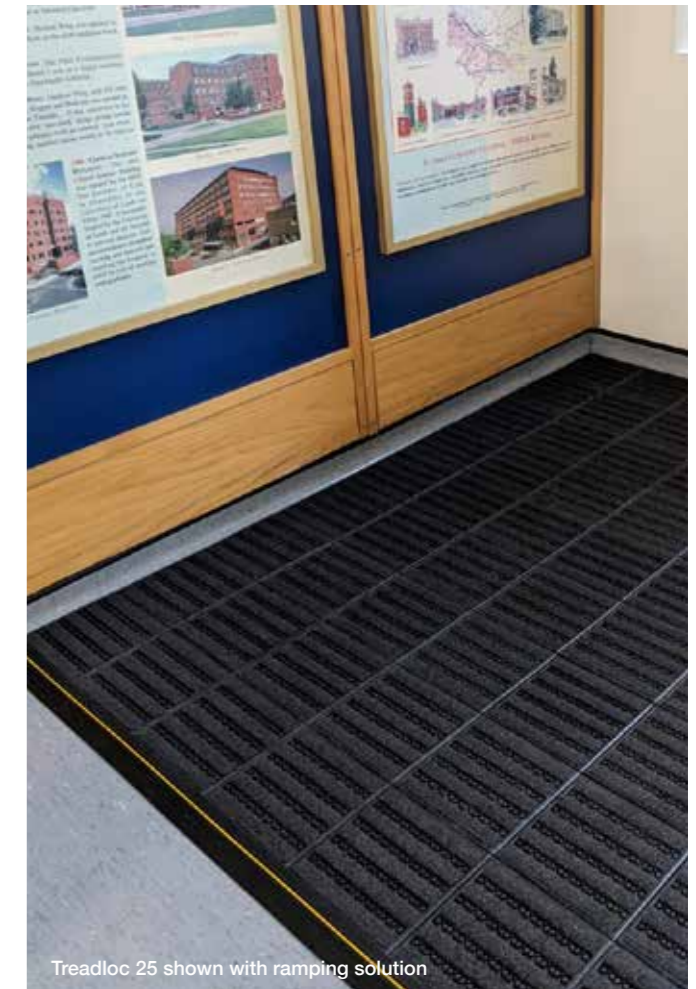

Treadloc 25 shown with ramping solution

## TREADLOC 25 RAMPING SOLUTION

### Description:

Treadloc 25 can be surface-mounted, with the option of a heavy duty click-fit ramping system, making the product suitable for buildings without a matwell or recess.

The heavy-duty ramped edges allow wheeled and trolley access, as well as helping to prevent trip accidents. The system allows our popular used to create a 'surface matwell' where a mat is laid directly on top of the floor.

### Key Features:

- Ramping system to enable Treadloc 25 to be surface-mounted
- Click fit mechanism for easy installation
- Made from durable rubber
- Pre-mitred corners for accuracy
- Available in 2m lengths
- Incorporate a colour of your choice into the ramp debris channel, for a striking and stand-out finish (as shown in the image on the left).

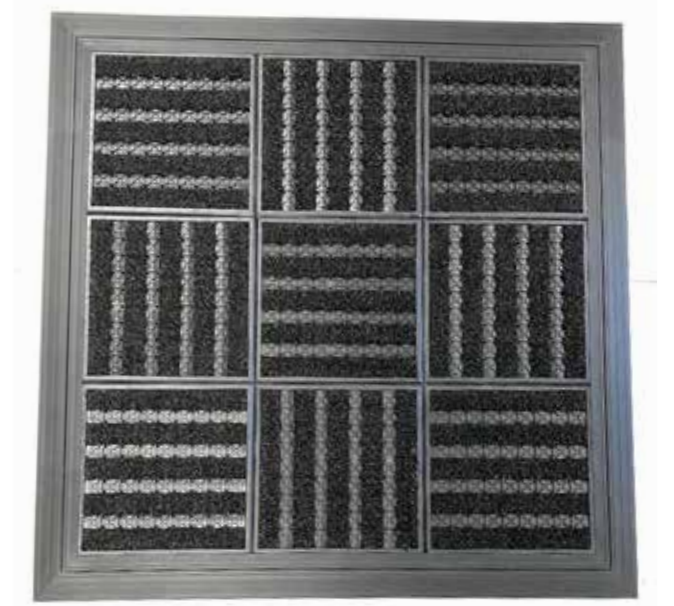
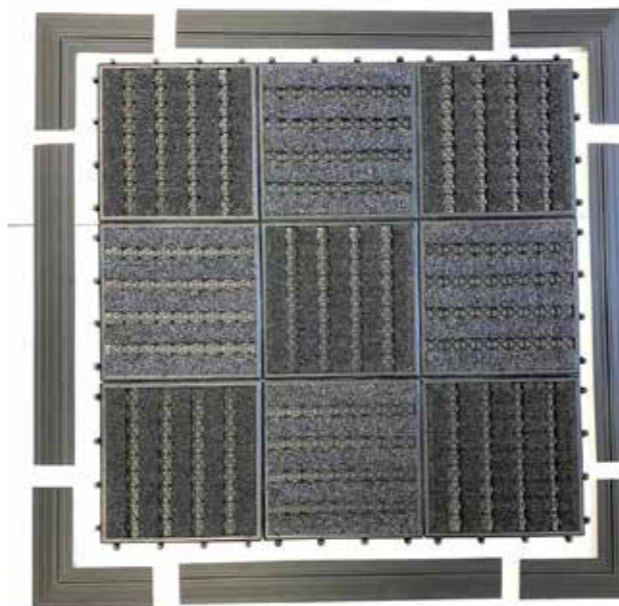

Treadloc 25 surface mounted with ramping solution

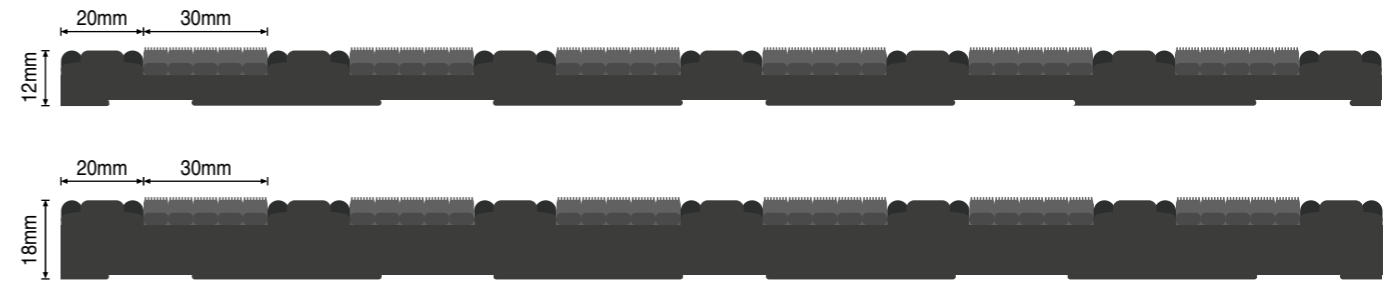
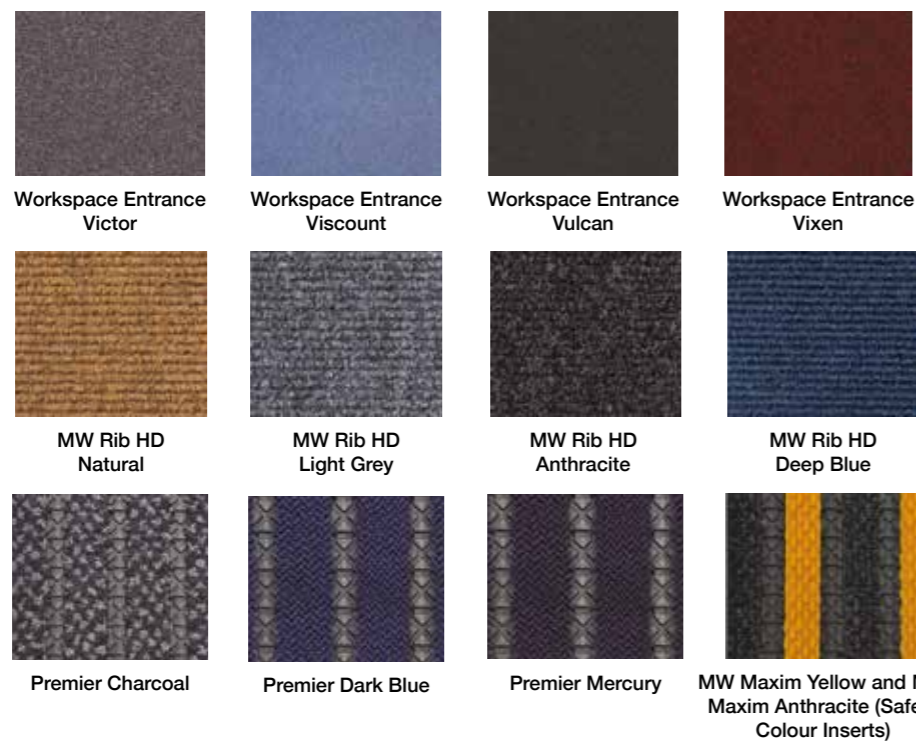

# TREADSURE 205

## Description:

Treadsure 205 by Mat.Works Entrance Solutions has been designed not just for extremely heavy footfall but also with wheeled traffic entrances in supermarkets, retail, education, and healthcare in mind - providing an alternative to aluminium matting systems. Manufactured from nitrile rubber to provide optimum performance and has a host of key features that set the product apart from any other standard modular matting system.

One of these is its sheer durability, which is provided by the product size and weight, ensuring it is one of the heaviest modular matting solutions available on the market. This sturdiness of Treadsure 205 provides significant durability when installed. It will not expand, contract, fade or become brittle, nor will it bend or buckle under pressure making it an ideal heavy contract solution for entrance areas in every sector.

The weight ensures, when installed correctly, that Treadsure will not move or slip in the matwell. It also makes installation easier, as there are no click or interlocking systems. If more than one system is needed, the modules are simply placed next to each other - significantly reducing any potential installation times.

Simple to install in most matwells.

Weight cannot be rivalled in the current market.

Will not buckle or bounce under pressure, making it suitable for wheel and trolley traffic.

Perfect for healthcare environments due to its copper compounds - a material that has been proven to have anti-microbial properties, combating the spread of hospital-acquired infections, including MRSA. Can be fitted with a host of carpet inserts and debris channel fillers to match any style

Can be fitted with a host of carpet inserts to match any style.

A cost-effective solution when compared to aluminium products.

## Technical data:

Module Size	205cm x 50cm x 12mm / 18mm
Seamless Installation	Seamlessly place two or more modules next to each other without the need for any locking mechanism
Composition	Nitrile rubber composition
Performance	Nitrile rubber is resistant to oil, grease, and fuel
Wear Classification	Heavy Contract Class 33
Weight	14,000gsm (12mm), 20,000gsm (18m)
Fire Rating	Cfl-s2
Anti-Microbial	Tested to ISO 22196
Anti-Slip	TRRL Pendulum test - very low risk for slips in both dry and wet conditions





Connect Entrack 50 together to create any size entrance mat required:

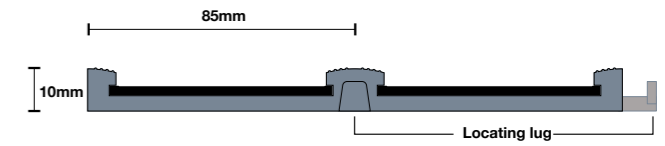

Mat.Works provides a survey and installation service on all Entrack 50 projects.



# ENTRACK 50

## Description:

A flexible modular system made from TPE which won't expand, contract or fade in colour. An extremely versatile product, Entrack 50 carpet strips are interchangeable to reduce life-cycle costs and the product is suitable for entrances with or without matwells.

High specification low profile platform.

Easy to cut and shape to bespoke patterns.

Recyclable and reusable.

Won't tap, bounce or buckle under heavy footfall.

Easily cut and trimmed on site.

Made in Britain.

Suitable for external or internal areas.

## Technical data:

Size	500 mm x 500 mm x10 mm
Insert width	85 mm
Connection	Integral 'lock down' fixing system
Colourway options	10
Environmental options	Recyclable and reusable
Base	Non-pvc polymer base

With its click fit connections, Entrack 50 can be installed with ease.



# ENTRACK 50





Tyre Tile

**Primary Entrance Matting -  
Manufactured using 100% recycled rubber**

# TYRE TILE

## Description:

Tyre Tile a fully recycled closed loop product.

Mat.Works has developed a value engineered product that is also a fully recycled matting system.

Tyre Tile incorporates recycled tyres as wiper strips within the products. Everyday 100,000 tyres are taken from cars, vans, trucks, buses and bicycles, what happens to them? Until recently most were either dumped or burnt, both of which are extremely harmful to the environment. Tyres that are illegally dumped in the countryside or in land fills are virtually impossible to break down due to the synthetic and chemical materials inside them, and when burnt these cause dense smoke and toxic fumes, many of which cause a damaging carbon footprint. We have introduced Tyre Tile as a product which has very little impact on the environment and as it uses 100% recycled or recyclable source material is value engineered to ensure it can fit into any project.

This gives us, the manufacturer, and you the consumer, the opportunity to reduce our carbon footprint by not using raw materials from source.

## Function:

Tyre Tile soil resistant mats are specifically recommended for covered areas, preferably recessed into the floor. These mats are designed for heavy duty wear in situations such as shopping centres, hospitals and public buildings.

The Tyre Tile mat is non-slip and extremely stable therefore this type of mat is absolutely safe for wheelchairs, high heels and walking sticks.

Made from 100% recycled tyres



## Technical data:

Weight	8410 gsm
Thickness	10 mm
Composition	Rubber tyre with nylon tread
Backing	Polyethylene webbing
Tile size	304 mm x 304 mm
Tiles per box	25/2.25 m <sup>2</sup>
Wear classification	Heavy contract
Flammability	DIN 4102, B1
Colour fastness To light	6
Wet rubbing	4-5
Dry rubbing	5
Wet shampoo	4-5
Colours options	1







Workspace Entrance



Premier



MW Maxim



MW Rib HD



DDA Coir



EXT Mat



# secondary entrance solutions

- WORKSPACE ENTRANCE
- PREMIER
- MW MAXIM
- MW RIB HD
- DDA COIR
- EXT MAT
- LOOSE LAY MATS



**Tough heavy contract, secondary entrance matting**



Vulcan



Victor



Viscount

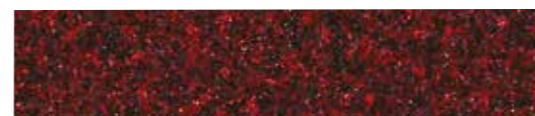

Vixen



**High specification, secondary entrance matting**

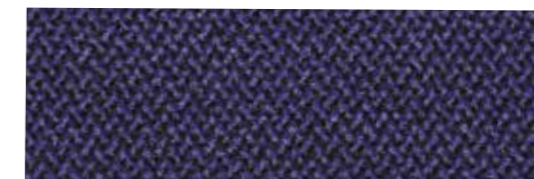

Dark Blue



Charcoal



Mercury

# WORKSPACE ENTRANCE

**Description:**

Tough heavy contract, secondary entrance matting.

All products conform to BS8300.

Low LRV Values compared to aluminium, LVL and fibrebonded products ensuring a positive point difference is easy to achieve for areas where partially sighted traffic will be important to consider.

Equalities Act 2010 compliant.

Entrance matting resistant to point loading and scuffing from rubber wheels and walking aids.

**Flame properties:**

Cfl-s1 for tiles

**Colours:**

Colour options available 4

**Technical data:**

Style	Tufted cut pile with integral scraper system
Fibre construction	100% solution dyed nylon
Tuft gauge	1/10"
Pile yarn weight	1,000 gsm
Pile height	5 mm +/- 0.5 mm
Pile density	114,260 tufts per square metre
Total weight	Tile 4,800 gsm / Sheet 1,800 gsm
Sheet thickness	Tile 9 mm / Sheet 8 mm
Backing	Bitumen compound / Eco-Bac / Unitary Bac
Dimensions	50 cm x 50 cm tile / 2 m x 20 m nominal
Wear classification	Heavy contract class 33
Colour fastness	To water - 5 To light - 5 To rubbing - 4.5
Flammability	Cfl-s1
Warranty	10 years

# PREMIER

**Description:**

High specification secondary entrance matting.

Made from 80% wool from renewable sources only.

Absorbs up to 4 times more moisture than man made fibres.

All products conform to BS8300.

Low LRV Values compared to aluminium, LVL and fibrebonded products. This ensures a positive point difference is easy to achieve for areas where partially sighted traffic will be important to consider.

Equalities Act 2010 compliant.

Entrance matting resistant to point loading and scuffing from rubber wheels and walking aids.

**Flame properties:**

Bfl-s1 (Tile only). (BS EN ISO 11925.2). (BS EN ISO 9239.1).

**Colours:**

Colour options available 3

**Technical data:**

Style	Tufted twist pile
Fibre construction	80% Wool / 20% Nylon + monofilament scraper
Tuft gauge	1/8"
Pile yarn weight	1500 gsm
Pile height	6 mm
Pile density	117,800 tufts per m2
Total weight	Tile 5300 gsm / Sheet 2300 gsm
Total thickness	Tile 12 mm / Sheet 10 mm
Backing	Unitary Bac Tile Backing Bitumen
Roll size	25.00 m x 2.00 m
Tile size	50 cm x 50 cm (Tile)
Wear classification	Heavy contract
Electro-static	Less than 2Kv
Colour fastness (BS1006)	
Light	(BS1006:B02) 5
Wet rubbing	(BS1006:B01) 4 - 5
Dry rubbing	(BS1006:X12) 4 - 5
Wet shampoo	(BS1006:UK-TB) 4 - 5



**SHEET AND TILE**



Anthracite



Light Grey



Deep Blue



Ocean Blue



Sage



Natural

**SHEET**



Slate



Sunset Red



Anthracite



Light Grey



Deep Blue



Natural  
(available in sheet only)

# MW MAXIM

**Description:**

As a heavy contract fibre-bonded carpet and featuring a multi-directional pattern, MW Maxim is perfect for a whole host of secondary entrances, including those in education environments, offices, retail and leisure.

MW Maxim is available in a variety of sheet and tile options (please contact a Mat.Works representative for details), alongside a wide-ranging colour bank, offering plentiful opportunities to create a unique entrance solution.

MW Maxim can also be offered as a bespoke logo entrance product.

Available in sheet or tile material.

**Technical data:**

Fibre construction	85% Polypropylene, 15% Recycled Polyester
Backing	Rubber Crumb (Sheet) Bitumen (Tile)
Roll Size	2 metre
Tile Size	50cm x 50cm
Weight	2500gsm (Sheet) 4400gsm (Tile)
Tiles Per Box	16 (4m <sup>2</sup> )
Thickness	10.50mm (Sheet) 11mm (Tile)
Light fastness ISO 105 B02	>6
Water fastness ISO 105 B01	5
Rubbing fastness ISO 105 X12	5
Flammability	(BS6307) Methanamine Pill Test - Pass
BS EN 13501	Class Efl (Sheet) Class Efl (Tile)

# MW RIB HD

**Description:**

Manufactured with a heavier weight fibre, heavy contract MW Rib HD is an enhanced hard-wearing carpet that can be installed in entrances, corridors and transition areas.

Available in sheet or tile material.

**Technical data:**

Fibre construction	85% Polypropylene, 15% Recycled Polyester
Backing	Bitumen (Tile)
Roll Size	2 metre, ribbing runs down length of roll
Tile Size	50cm x 50cm
Colours	3
Weight	1900gsm (Sheet) 4400gsm (Tile)
Tiles Per Box	16 (4m <sup>2</sup> )
Thickness	10mm (Sheet) 11mm (Tile)
Light fastness ISO 105 B02	6
Water fastness ISO 105 B01	5
Rubbing fastness ISO 105 X12	5
Flammability	(BS6307) Methanamine Pill Test - Pass
BS EN 13501	Class Efl (Sheet) Class Efl (Tile)

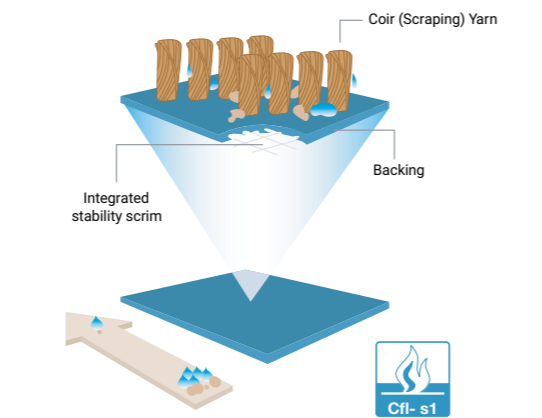

DDA Coir

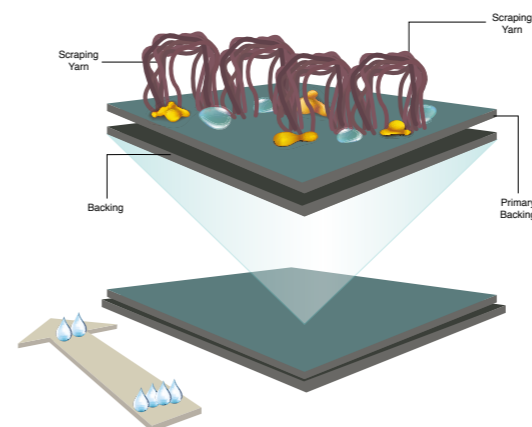

Brown

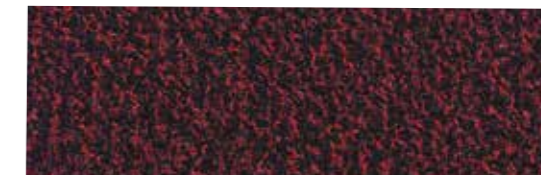

Red



Anthracite

## DDA COIR

### Description:

Our Mat.Works DDA Coir is hard-wearing and satisfies all official commercial requirements, which is unique for a coir product. It complies with the rigorous European Fire Safety requirements (Cfl-S1) and has a wear classification of Class 32 (BS EN 1307) Coir is a natural material which looks great, offers excellent durability and also absorbs a great deal of dirt and moisture, which means you will save on cleaning costs.

The yarn is mechanically spun to ensure a uniform and regular pattern with minimal fibre loss.

This product can absorb up to eight litres of water per square metre, producing unrivalled performance in this product sector.

This product is constructed using an unique glass scrim which means that this product is hardly affected at all by stretching and is extremely stable. That means it is also ideal for wheelchair users and presents no problems at all for people on crutches or wearing high heeled shoes.

**Unique glass scrim layer means DDA Coir is more stable, more densely packed than other products - making it ideal to handle wheeled traffic, crutches and high heels.**

### Technical data:

Pile material	100% machine spun coir yarn
Backing	PVC with integrated stability scrim
Yarn construction	Velour
Pattern	Uni
Colours	1
Pile weight ISO 8543	± 3.50 kg m <sup>2</sup>
Total weight ISO 8543	± 6.85 kg m <sup>2</sup>
Pile height ISO 1766	14 mm
Total height ISO 1765	17 mm
Number of stitches ISO 1763	± 41.800/m <sup>2</sup>
Wearing class EN 1963	32
Comfort EN 1307	LC5
Light fastness ISO 105 B02	> 6
Water fastness ISO 105 B01	3-4
Rubbing fastness ISO 105 X12	3-4
Salt water ISO 105 E02	3-4
Shampoo BS 1006	3-4
Organic solvents ISO 105 X05	3-4
Absorption capacity TNO W6034	17 mm: ± 8,4 l/m <sup>2</sup>
Flammability	(BS6307) Methanamine Pill Test - Pass
BS EN 13501	Cfl
Slip resistance EN 13893	DS
Static charge ISO 6356	2,0 kV
Declaration of performance	Available
Sizes rolls	200 cm
Roll length	± 10 m

## EXT MAT

### Description:

EXT MAT is a special outdoor mat that pairs scraping qualities with moisture absorption. The outdoor mat is available in three colours and suits every entrance.

EXT MAT is a robust mat that is ideal for heavy commercial use. It works best in entrance areas, stairwells, hospitality areas & lifts, for example, in commercial buildings and medium-sized and large offices.

EXT MAT stands out in terms of moisture absorption. Consequently, the mat is optimised for scraping. Small areas of dirt in the mat are not visible. This product can be used inside or outside and provides a durable solution in high traffic areas thanks to its Bouclé construction. The slightly blended design features coarse yarns only.

EXT MAT is a versatile outdoor mat fitting many different situations. This is down to its practical and versatile appeal. Even if the mat is used indoors it continues to perform to the highest standards by preventing dirt and moisture ingress reaching internal floors within a building.

### Technical data:

Pile material	100% Polyamide Backing PVC
Primary backing	nonwoven PET/PA Yarn
Construction	Bouclé
Pattern	Blended
Colours	3
Pile weight ISO 8543	± 600 g/m <sup>2</sup>
Total weight ISO 8543	± 3,000 g/m <sup>2</sup> pile
Height ISO 1766	± 6.5 mm
Total height ISO 1765	± 8.0 mm
Pile density ISO 8543	0.079 g/cm <sup>3</sup>
Number of stitches ISO 1763	± 64,500 /m <sup>2</sup>
Use classification EN 1307	33
Wearing class EN 1963	33
Comfort EN 1307	LC1
Suitability for stairs EN 1963	Intensive use
Suitability for castor chairs EN 985	Occasional use
Dimensional stability ISO 2551	<0.4%
Light fastness ISO 105 B02	>7
Water fastness ISO 105 B01	4 - 5
Rubbing fastness ISO 105 X12	4 - 5
Salt water ISO 105 E02	4 - 5
Shampoo BS 1006	4 - 5
Organic solvents ISO 105 X05	4 - 5
Absorption capacity TNO W6034	± 3.8 l/m <sup>2</sup>
Flammability	(BS6307) Methanamine Pill Test - Pass
BS EN13501	Cfl
Slip resistance EN13893	DS
Static charge ISO 6356	<0.1 kV
Roll widths	200 cm
Roll length	± 20 m



## LOOSE LAY MATS

### Description:

Perfect for hallways, lift areas, receptions and as a secondary entrance product, the Mat.Works Loose Lay Mat provides quality performance, with all the benefits of a moveable mat.

The Loose Lay Mat is available in a variety of widths (please see the specification for further details), comes in lengths up to four metres and features nine popular neutral colours that are ideal for most commercial environments.

The surface is manufactured using high twist nylon, which delivers a high-class finish, while the 100% nitrile rubber backing provides the support required to ensure minimal slips and trips.

### Stock Sizes

#### Loose Lay Standard

60 x 85 cm  
 85 x 120cm  
 85 x 150cm  
 115 x 175cm  
 115 x 175 cm  
 115 x 200cm  
 115 x 240cm  
 150 x 250cm  
 200 x 300cm

### Technical data:

Weight	2.40kg/m <sup>2</sup>
Thickness	Approx. 11 - 12mm
BS EN 13501	Class CfI-s1
Static Electrical Propensity	EN 14041 Antistatic
Standard Widths	85 cm, 115 cm and 150 cm Black Pearl, Black Steel, Black Cedar, Granite and Midnight Grey up to 200 cm (With borders) 3 cm smaller than for mats with borders (Without borders)
Standard Lengths	All lengths up to 400cm
Bespoke	Up to 700cm
Backing	100% Nitrile rubber, available with kleeled or smooth backing)
Rubber Thickness	1.40mm
Rubber Weight	1.70kg/m <sup>2</sup>
Border Width	20mm (Available without borders)
Colouration	Solution dyed
Application Areas	Entrances, hallways, elevators, receptions and restrooms
Cleaning	Washable up to 60 °C Tumble dry up to 60 °C



Coir Logo



Brush Logo



MW Maxim Logo

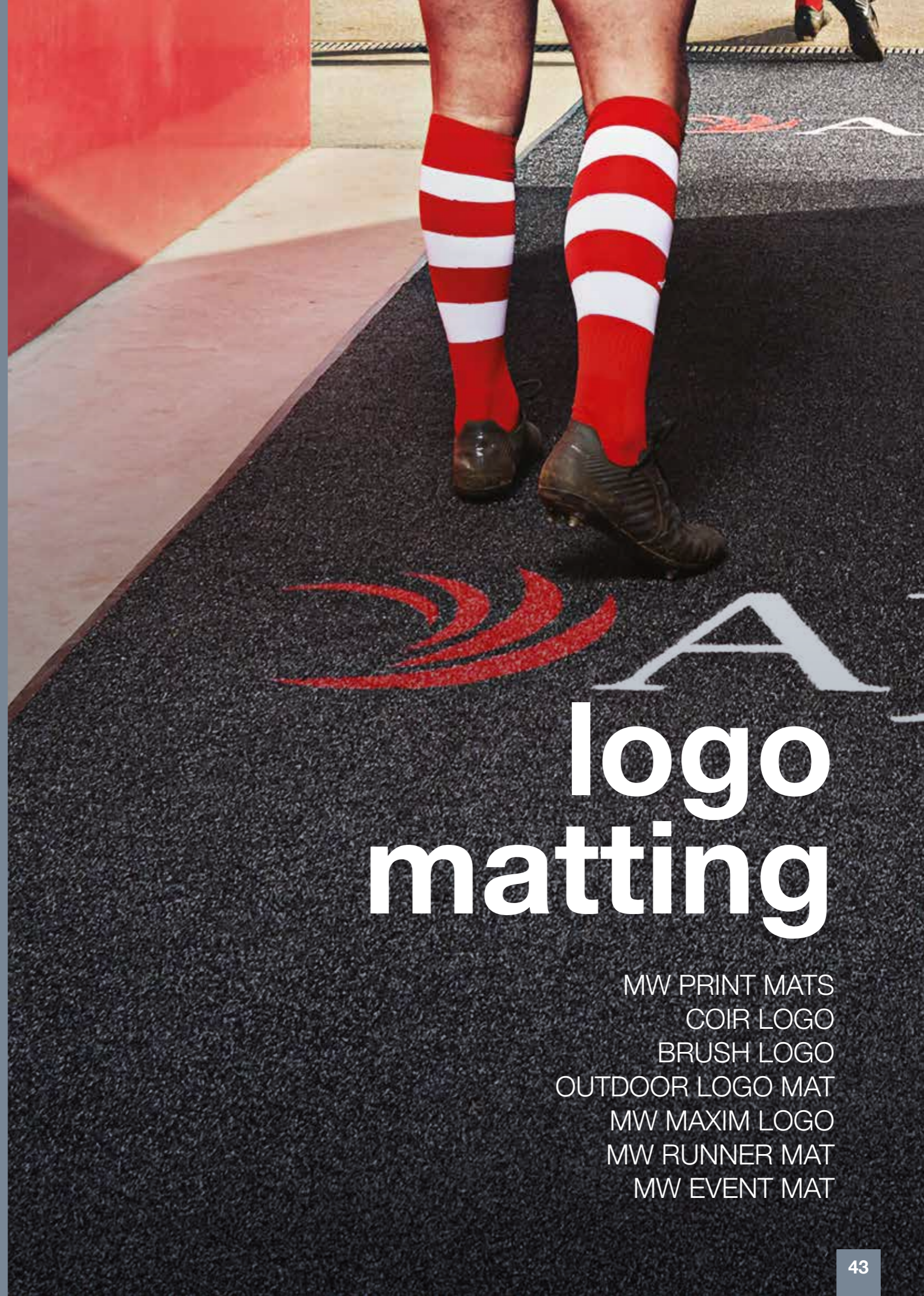

# logo matting

- MW PRINT MATS
- COIR LOGO
- BRUSH LOGO
- OUTDOOR LOGO MAT
- MW MAXIM LOGO
- MW RUNNER MAT
- MW EVENT MAT



Borderless with extra 3mm DMS rubber backing (suitable for mat wells)



(Colours shown may deviate slightly from the original colours).



### High specification, secondary entrance matting



Coir Natural



Coir Black

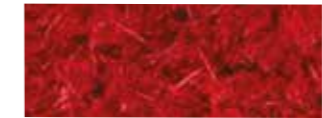

Coir Red



Coir Green



Coir Light Grey



Coir Tan



Coir Brown

## MW PRINT MAT

### Description:

This truly high quality multi-functional dust control mat not only cleans and dries shoe-soles preventing dirt and moisture being tracked into facilities. It also provides an excellent opportunity to address safety issues as most people primarily look to the floor.

Superior colour fastness is ensured, in accordance with DIN54006. We work with a large selection of PMS colours, which allows any other colour to be matched. Printed Mats offers a state-of-the-art technology that even allows 3-dimensional effects, fine lines and colour shading, so each mat has a truly individual customised image.

### Technical data:

Tufted cut loop carpet mat consisting of 100% non-crush polyamide 6.6 high twist yarn, approx 700 gr/m<sup>2</sup>.  
Nitrile rubber backing, 1.5 mm thick.  
Non slip-gripper backing.  
Enforced borders, do not curl in cold weather and will not tear.  
Machine washable at 50°C.  
Oil and microbe resistant.  
Excellent moisture absorption capacity: >4 ltr/m<sup>2</sup>.  
Pile height 7mm.  
Overall thickness: 8.5 mm.

### How to order

- 1 Title or name:** Give any name relevant to the design.
- 2 Send logo or image to sales@mat-works.co.uk:** Acceptable formats are JPG, TIF, EPS, PCX, Adobe Illustrator, Certified PDF. In case no logo is available, text is also possible. In such case, give text, preferred letter type and letter colour.
- 3 Sizes:** Select required mat size. 60cm, 75 cm, 85 cm, 115 cm, 150 cm and 200 cm including border lengths up to 400 cm. Sizes are approximate, subject to a tolerance of about 3%.
- 4 Orientation:** Landscape or portrait.
 

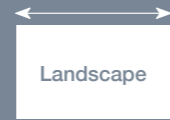

Landscape

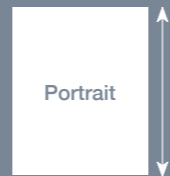

Portrait
- 5 Background colour:** Recommended are dark colours.
- 6 Quantity:** Indicate number of mats. More mats per design lowers the cost.

## COIR LOGO

### Description:

Coir is traditional and effective barrier matting, made with 100% natural fibres. Perfectly suitable for both commercial and domestic entrance areas. Coir matting will capture a large amount of moisture and provides excellent airflow for efficient vacuuming.

### Flame properties:

BS 4790 (low radius of char)

### Maintenance:

Regular vacuuming with suction attachment. Occasionally reverse the matting.

### Installation:

Sub floors should be clean, dry and flat and prepared in accordance with BS5325. Entrance area sheet should be fully adhered.

### Technical data:

Manufacturing process	Pile implant
Surface aspect	Cut pile
Pile material	100% coir - high twist yarns made from coconut husk fibre
Backing	PVC
Overall thickness	17 mm
Weight	2700 grams/m <sup>2</sup> (17 mm quality)
Total weight	5700 grams/m <sup>2</sup> (17 mm quality)



### High specification, secondary entrance matting



Brush Rib Anthracite



Brush Rib Black



Brush Rib Blue



Brush Rib Brown



Brush Rib Green



Brush Rib Natural



Brush Rib Red



## BRUSH LOGO

### Description:

Coir is traditional and effective barrier matting, made with 100% natural fibres. Perfectly suitable for both commercial and domestic entrance areas. Coir matting will capture a large amount of moisture and provides excellent airflow for efficient vacuuming.

### Flame properties:

Efl- s1

### Colours:

Colour options available 7.

### Maintenance:

Regular vacuuming with suction attachment

### Installation:

Sub floors should be clean, dry and flat and prepared in accordance with BS5325. Entrance area sheet should be fully adhered.

### Tolerances:

The above information is given in good faith and all sizes and weights are subject to manufacturing tolerances.

### Technical data:

Manufacturing process	Non-woven needled
Surface aspect	Looped fibres ribbed
Pile material	100% synthetic stain resistant fibre
Backing	Water resistant SBR latex
Overall thickness	13 mm
Pile weight	1700 grams/m <sup>2</sup>
Total weight	2700 grams/m <sup>2</sup>

## OUTDOOR LOGO MAT

### Description:

The Mat.Works Outdoor Logo Mat is a truly bespoke innovative printed logo mat that has been specifically designed for outdoor use. With a host of colours available, and with colour matches optional, the Mat.Works Outdoor Logo Mat can echo your brand or company and provide a professional welcome to all.

The Outdoor Logo Mat has a durable nylon grass effect finish, making it ideal for all outdoor placements, entrances, sports booths, sales events, commercial buildings, the public sector and much more.

Mat.Works provides the Outdoor Logo Mat in all shapes and sizes, however, the standard widths (including borders) are; 50cm, 85cm, 115cm, 150cm and 200cm. The standard length is anything up to 400cm, however, up to 700cm can be accommodated for with special projects.

The heavy-duty nature of the product, which includes a two-year guarantee, provides peace of mind that the Outdoor Logo Mat will stand the test of time even in the harshest environments.

### Technical data:

Weight	3.60kg/m <sup>2</sup>
Thickness	Approx. 8 mm
Standard Widths	50cm, 85cm, 115cm, 150cm and 200cm (With borders) 3cm smaller than for mats with borders (Without borders)
Standard Lengths	All lengths up to 400cm
Bespoke	Up to 700cm
Backing	100% Nitrile rubber, available with kleeled or smooth backing)
Rubber Thickness	1.80mm
Rubber Weight	2.20kg/m <sup>2</sup>
Border Width	20mm - available with or without borders
Colouration	Chromojet printing process
Application Areas	Outdoor placement, entrances, sales booths, sport events
Cleaning	Regularly cleaned with a SEBO BS 360 vacuum cleaner





## MW MAXIM LOGO

### Description:

MW Maxim Logo mat is a bespoke entrance mat perfect for a wide range of environments, including offices, education facilities, retail, leisure and much more.

Almost all designs can be created using the MW Maxim product, making it truly a unique heavy contract commercial entrance system.

MW Maxim Logo designs can be created using a selection of 21 colours.

### Technical data:

Product	MW Maxim Heavy Contract Entrance Area Carpet
Fibre construction	80% Polypropylene, 15% Recycled Polyester
Weight	2550gsm
Thickness	10.50mm
Light fastness ISO 105 B02	>6
Water fastness ISO 105 B01	5
Rubbing fastness ISO 105 X12	5
Flammability	(BS6307) Methenamine Pill Test - Pass
BS EN 13501	Class Efl (Sheet)

## MW RUNNER MAT

### Style information and data

This stunning bespoke runner mat is not only stylish, but practical too. Tailored to your logo and branding requirements, the mat encourages a grand entrance, immediately grabbing attention with beautiful graphics on its velour surface.

For all mats we reserve the right of a production-related tolerance of +/- 5% in colour, size and quantity.

### Technical data:

Product	MW Runner Mat
Standard Sizes	Broadloom
Standard Width	205cm (with side borders)
Maximum Length	Up to 20m
Other Sizes	Available on request
Total Mat Weight	2.45 kg/m <sup>2</sup>
Border Width	25mm
Border Thickness	1.5mm
Min Order Quantity	1m <sup>2</sup>
Pile	100% velours, polyamide 6
Pile Weight	325 g/m <sup>2</sup>
Pile Height	2.5mm (+/- 0.5mm)
Total Mat Height	5mm (+/- 0.5mm)
Backing	Vinyl
Border Thickness	1.5mm



# accessories

## Ramped frames & surface mounted installations:

Internal and external ramp frames are supplied mitred and drilled.  
The surface is ribbed for enhanced grip



## Treadloc 25 Ramping Solution

Give Treadloc 25 added flexibility with the additional surface mounted ramping solution.  
See pages 22 and 23 for more information.

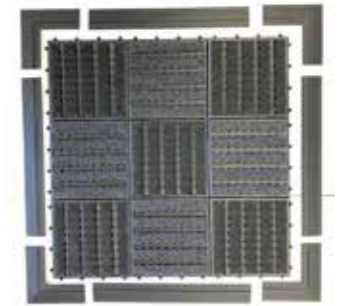

## T-Bars

Mat.Works T-Bars provide separation between modules.

**Available for all Frameworks products.**



## Framing

Mat.Works has a range of framing options to suit every matting requirement.

**Frames range from 10 mm to 25 mm on all Frameworks products.**



## MW EVENT MAT

### Style information and data

This stunning event mat with superb graphic quality, is entirely bespoke and tailored to your logo or branding needs. With special shapes available, it is 100% velour and PVC free.

For all mats we reserve the right of a production-related tolerance of +/- 5% in colour, size and quantity. Colours are subject to commercial tolerance.

### Technical data:

Product	MW Event Mat
Customs Tariff No.	57032018
Widths	Up to 2m
Lengths	Up to 20m <small>(depending on size, one cut will be charged)</small>
Total Mat Weight	1.10 kg/m <sup>2</sup>
Overall Height	Approx. 6mm
Application Areas	Events, Exhibitions, Trade Fairs
Min Order Quantity	From 1m <sup>2</sup>
Colouration	Chromjet Printing Process
Pile	100% Polyamide 6
Pile Height	Approx. 3mm
Pile Weight	325 g/m <sup>2</sup>
Backing	Latex WV Backing
Cleaning	Carpet Cleaning/ Vacuum Cleaners

# cleaning guide

## Rollable primary matting systems

**Daily** - Vacuum clean

**Weekly** - Removal of grit, etc. and vacuum clean. Removal of chewing gum

**Monthly** - Removal of large grit, etc. and vacuum clean. Cleaning of matwell: - roll up mat and extract dirt / grit from under the mat. Check retainer screws at all 4 corners of mat and replace mat after cleaning making sure retainer screws are secure.

**Periodically** - Removal of large grit, etc.+ vacuum clean. Cleaning of matwell by roll up the mat and extract dirt grid from under the mat. Check retainer screws and replace mat after cleaning making sure retainer screws are secure. Accumulating dirt underneath the mats may undermine the structure of the mat.

Cleaning frequency is subject to amount of traffic, surroundings and weather conditions.

## Modular primary matting systems

**Daily** - Vacuum clean

**Weekly** - Removal of grit, etc. vacuum clean. Removal of chewing gum\*

**Monthly** - Remove large grit from the mat well by vacuum cleaning. Thoroughly clean mat well: - Take modules up and extract dirt / grit from under the mat. Replace modules in exact order they came out.

**Periodically** - Removal of large grit, etc. + vacuum clean.

**Cleaning of matwell:** - Take up modules extract dirt / grit from under the mat. Check sub floor is sound and replace modules in exact place where they were found. We also recommend that a periodic deep clean using hot water extraction is used to remove deep set dirt within the mat. (Specialist cleaning firms can be recommended).

Cleaning frequency is subject to amount of traffic, surroundings and weather conditions.

\*NB:- removal of chewing gum is best using a proprietary gum removal gel such as that from fleetlight tel:- 02084667848.

**Maintenance Specification for Mat.Works Entrance Carpets and Carpet Tiles** - To maximise the entrance carpet's aesthetic appeal, performance and life expectancy, it is imperative to ensure at the specification stage that:

1. Carpets will be protected from other site activities during installation and thereafter.
2. Clients understand the enclosed information and that they accept responsibility for correct carpet care. (Mat.Works will provide a copy of the Cleaning and Maintenance guide to the end-users address when requested.)

**General Cleaning** - Daily vacuuming with a rotary brush vacuum cleaner, preferably with an adjustable head, is recommended. It is essential to remove all loose soil daily because if left to build up, the particles of dirt are much harder to remove and are more damaging to the yarn structure, thereby decreasing the life of the carpet.

Entrance Areas are prone to higher traffic levels and higher levels of dirt and moisture. This means that the maintenance program for entrance matting should be more frequent than for general carpeting areas, a ratio of 2 entrance cleans to 1 carpet clean is a general good guide for preventative periodical maintenance.

Depending on the level of trafficking, the carpet should be periodically deep cleaned using high performance hot water extraction equipment. In certain circumstances, for instance excessively stained carpet the cleaning professional may consider a combination between rotary brush and extraction equipment to give improved results. Rotary brush cleaning by itself is not recommended.

A reputable contract cleaner should be used, preferably NCCA registered (for NCCA details telephone 0116 271 9550). It is important that the carpet is deep cleaned at least once a year.

**Stain Removal** - It is essential to deal with spillages immediately and any subsequent stains as appropriate. In the event of a spillage, immediately blot with a clean absorbent cloth until there is no further transfer from the carpet to the cloth. If any further stain remains or has otherwise been allowed to dry, the method will vary accordingly.

It is recognised that particularly for contract situations, if stains are not dealt with immediately, cleaning staff may not be in a position to identify the type of stain. A good quality, multi-purpose stain remover is therefore very useful, although it must be understood that this will not successfully tackle all types of stains, and wherever possible the chart recommendations should be strictly adhered to (see right). Also any stains left over a period of time become increasingly more difficult to remove and may require several treatments.

In all cases after stain removal the carpet should be allowed to dry completely and then cleaned with a rotary brush vacuum cleaner.

Solvent cleaning of bitumen backed tiles should preferably be avoided. Where this is not possible, extra caution should be taken and only very light surface cleaning should take place.

## Special Cases

**Cigarette burns** – it is recommended that these are punched out and replaced by a professional carpet fitter.

**Major spillages** – seek professional advice from a member of the NCCA.

If any of the treatment lists are not successful, seek professional help. The methods are based upon experience and are recommended in good faith. However, we cannot accept responsibility for their use in any specific case.

## cleaning & maintenance cleaning solutions & methods

Cleaning method A	Type of stain
<p>A liquid detergent such as Granwax spot/stain remover, in accordance with manufacturers instructions.</p> <p>Granwax tel no: 01773 541177</p>	<p>Alcoholic beverages Baby or animal stains Blood (wet) Coffee, tea chocolate Minerals and fruit juices Water based paint Food Fountain pen ink Vomit Oil based paint or varnish Butter and other greases Cooking oils and other oils Ointment Metal polish Tar Cream, ice-cream and milk</p>
Cleaning method B	Type of stain
<p>A dry solvent spotter such as Prochem solvall.</p>	<p>All inks except fountain pen ink</p>
Cleaning method C	Type of stain
<p>Methylated spirits. Method: Moisten a cloth with the appropriate solvent and dab onto the stain. Carry on using alternate moist and dry cloths until no further stain transfer. Finally, cover the damp area with a thick wad of dry cloths, cover with something heavy and leave for several hours.</p>	<p>Coffee, tea, chocolate</p>
Cleaning method D	Type of stain
<p>A paste made with biological washing powder and mixed to use as little water as possible. Method: Moisten stain with warm water and cover with the paste. Keep moist for approximately 2 hours. Sponge with clean warm water and blot with an absorbent cloth.</p>	<p>Dried blood</p>
Cleaning method E	Type of stain
<p>Scrape off the excess with a blunt edged knife. Use proprietary chewing gum remover. Contact Granwax for advice.</p> <p>Granwax tel no. 01773 541177</p>	<p>Chewing gum Blu-tack Plasticine</p>

# National Floorcoverings

## Our Heritage - Our Future

Producing a wide variety of products from entrance matting, fibre bonded carpets for the education market, tufted carpet and tiles for the commercial sector to specialised indoor and outdoor sports surfaces, the group has expertise in all flooring fields.

The family is dedicated to maintaining and developing its UK manufacturing base with customer support. It takes a colossal supply network to ensure a combined 500,000 sq.ft. of facilities run efficiently. In support of the local community, suppliers are often used in the surrounding vicinity of the factories.

By striving to be No.1 in sustainable design for flooring solutions the family of companies has established strong international export presence in more than 50 countries.

Where tested, the group has BRE 'A+' Ratings for its products, being the highest environmental standard currently available.

With clients such as Google, Apple, Local Authorities, the Health Service, the Ministry of Defence, there is always a requirement to provide the highest quality products using the most technologically advanced production processes and therefore commanding a route to the future.

**Mat.Works, part of National Floorcoverings, is committed to UK manufacturing and the very best environmental practices**

National Floorcoverings UK have a strong international export presence in more than **50 countries**.

Across the UK, the group employs **over 350** people, most of which are local to the five manufacturing facilities in Yorkshire and Derbyshire.

National Floorcoverings is a **UK family owned business** which, along with associated family businesses, has a turnover exceeding £60m.



# contacts

## Sales

Tel: +44 (0) 1709 763 839  
Fax: +44 (0) 1709 763 813  
Email: sales@mat-works.co.uk

## Samples

Tel: +44 (0) 1709 763 805  
Fax: +44 (0) 1709 763 813  
Email: samples@mat-works.co.uk

## Divisional Manager Matthew Evans

Tel: +44 (0) 7778 419 035

Email: mevans@mat-works.co.uk

As part of National Floorcoverings, Paragon Carpet Tiles' area managers provide sales support to Mat.Works nationwide, visit: [www.paragon-carpets.co.uk/sales-team](http://www.paragon-carpets.co.uk/sales-team) to find a local representative.

# NOTES/DRAWINGS





# mat.works

Entrance Solutions

part of the group



- Commercial Entrance Matting
- Health & Safety Specialists
- ISO 14001 Accredited
- ISO 9001:2000 Accredited
- Disability Act Specialist

Farfield Park, Manvers, Wath-upon-Deerne, Rotherham, S63 5DB

T: +44 (0) 1709 763 839  
F: +44 (0) 1709 763 813  
E: [sales@mat-works.co.uk](mailto:sales@mat-works.co.uk)  
W: [www.mat-works.co.uk](http://www.mat-works.co.uk)

Marketing/Samples Department:  
T: +44 (0) 1709 763 805  
F: +44 (0) 1709 763 813  
E: [samples@mat-works.co.uk](mailto:samples@mat-works.co.uk)